

Making cooking as much fun as eating

Please read this instruction manual. This will ensure that you make use of all the technical benefits the cooker has to offer.

It will provide you with important safety information. You will then be familiarised with the individual components of your new cooker. And we will show you how to make settings step by step. It is quite simple.

The tables list the settings and shelf positions for numerous well-known dishes. All these dishes are tested in our cooking studio.

In the unlikely event of a fault, look here for information on how to rectify minor faults yourself.

A detailed table of contents will help you to find your way around quickly.

Enjoy your meal!

Instruction manual

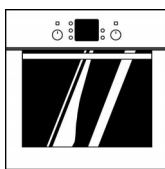

HBN 2302.0 A

en

5650 028 820

Table of contents

Important information	4
Before installation	4
Safety information	4
Reasons for damage	5
Your new cooker	6
The control panel	6
Function selector	6
Temperature selector	7
Control buttons and display panel	7
Types of heating	8
Oven and shelving accessories	9
Cooling fan	12
Before using for the first time	13
Heating up the oven	13
Pre-cleaning the accessories	13
Setting the oven	14
Switching off the oven manually	14
If the oven is to switch off automatically	15
If the oven is to switch on and off automatically	16
Rapid heating	17
Setting procedure	17
Time	18
Setting procedure	18
Timer	19
Setting procedure	19
Basic settings	20

Table of contents

Changing the basic settings	21
Childproof lock	22
Care and cleaning	22
Oven exterior	22
Oven	23
Cleaning the glass panels	24
Cleaning the rails	25
Seal	25
Accessories	25
Troubleshooting	26
Replacing the oven light	26
After-sales service	27
Packaging and old appliances	27
Tables and tips	28
Cakes and pastries	28
Baking tips	31
Meat, poultry, fish	32
Tips for roasting and grilling	36
Bakes, gratins, toast	36
Frozen foods	37
Defrosting	38
Drying	38
Preserving	39
Energy saving tips	41
Acrylamide in food	41
What can you do?	42
Test dishes	43

Important information

Read this instruction manual carefully. Only then will you be able to operate your cooker safely and correctly.

Please keep the instruction and installation manual in a safe place. Please pass on the instruction manual to the new owner if you sell the appliance.

Before installation

Transport damage

Check the appliance after unpacking it. Do not connect the appliance if it has been damaged in transport.

Electrical connection

The cooker may only be connected by an approved specialist. Losses resulting from damage caused by incorrect connection will invalidate warranty claims.

Safety information

Hot oven



This appliance is intended for domestic use only. Only use the cooker for food preparation.

This product is not intended for use by young children or infirm persons without supervision.

Open the oven door carefully. Hot steam may escape. Never touch the internal surfaces of the oven or the heating elements. There is a risk of burning. Children must be kept at a safe distance from the appliance.

Never store combustible items in the oven. Risk of fire

Never clamp leads of electrical appliances in the hot oven door. The insulation on the leads could melt. There is a risk of short-circuiting.

Repairs



Incorrectly done repairs are dangerous. There is a risk of electrocution.

Repairs may only be carried out by after-sales service technicians who have been fully trained by BSH.

If there is a fault, switch off the oven fuse at the fuse box.

Call the after-sales service.

Reasons for damage

Baking sheet or aluminium foil on the oven floor

Do not place baking sheets on the oven floor. Do not line the oven floor with aluminium foil.

This causes heat to accumulate. Baking and roasting times will no longer be correct and the enamel will be damaged.

Water in the oven

Never pour water directly into a hot oven. This could damage the enamel.

Fruit juice

When baking very moist fruit cakes, do not put too much on the baking sheet. Fruit juice dripping from the baking sheet leaves stains that cannot be removed.

It is recommended that you use the deeper universal pan.

Cooling with the oven door open

Only leave the oven to cool with the door closed. Do not allow anything to become trapped in the oven door. Even if you only leave the oven door open slightly, the fronts of adjacent units may become damaged over time.

Very dirty oven seal

If the oven seal is very dirty, the oven door will no longer close properly when the oven is in use. The fronts of adjacent units could be damaged. Keep the oven seal clean.

Using the oven door as a seat

Do not stand or sit on the oven door.

Your new cooker

Here you will learn more about your new oven. The control panel and its switches and indicators are explained here. The heating modes and the accessories included with your oven will be explained here.

The control panel

Details vary according to the appliance model.

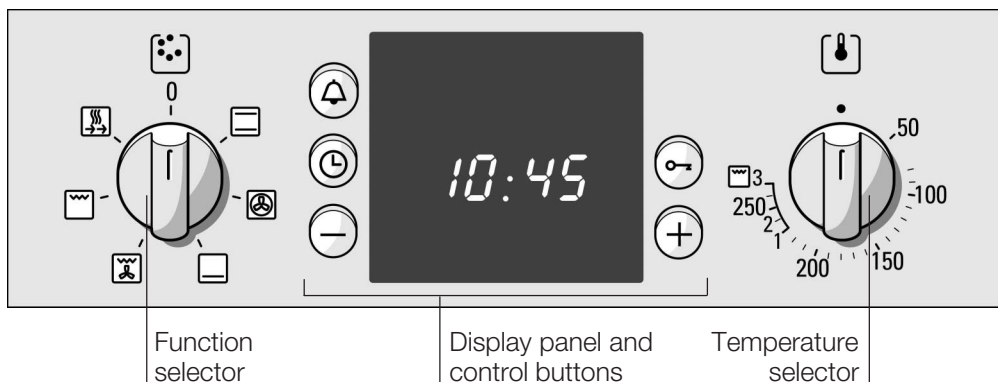





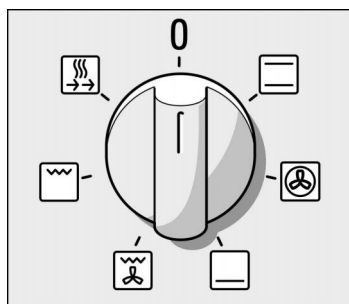

Function selector

Use the function selector to select the type of heating for the oven.



Settings

	Top/bottom heating
	3D hot air
	Bottom heating
	Hot air grilling
	Radiant grill
	Rapid heating

The oven light switches on when you select a function.

Temperature selector

Use the temperature selector to set the temperature or grill setting.

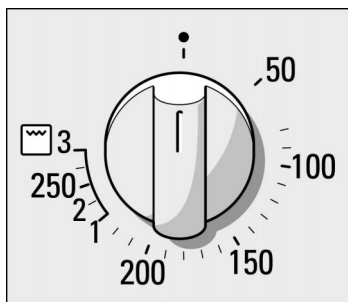

Temperature

50 - 270	Temperature range in °C
----------	-------------------------

Grill

1	Low grill
2	Medium grill
3	High grill



The temperature symbol in the indicator comes on while the oven is heating up. It goes out during pauses in heating. The symbol does not come on for grilling.

Grill settings

You can select a grill setting on the radiant grill  using the temperature selector.

Control buttons and display panel



Timer button 	Use this button to set the timer.
Clock button 	Use this button to set the time of day, the cooking time $\text{I} \rightarrow \text{I}$ and the completion time $\rightarrow \text{I}$.
Minus button -	Use this button to reduce the values set.
Plus button +	Use this button to increase the values set.
Key button 	Use this button to switch the childproof lock on and off.

The values set can be seen in the display panel.

Types of heating

Different types of oven heating are available. You can therefore select the best method for cooking any dish.

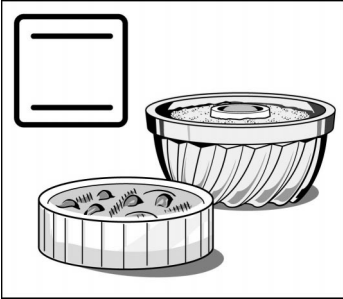

Top/bottom heating

This ensures the even distribution of heat onto the cake or roast from the top and bottom of the oven. This type of heating is best for cake mixtures in tins or for bakes. Top/bottom heating is also suitable for cooking lean roasts of beef, veal and game.

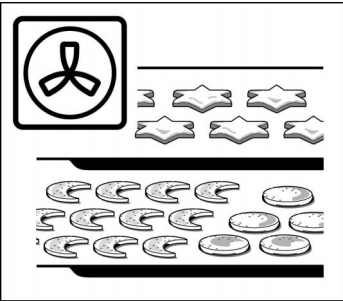

3D hot air

A fan in the rear panel distributes the heat from the ring heating element evenly inside the oven. Using 3D hot air, it is possible to bake cakes and pizza on two shelves. You can cook biscuits and puff pastry on three levels at the same time. The required oven temperatures are lower than those for top/bottom heating. Additional baking trays may be obtained from specialist shops.

3D hot air is ideal for drying food.

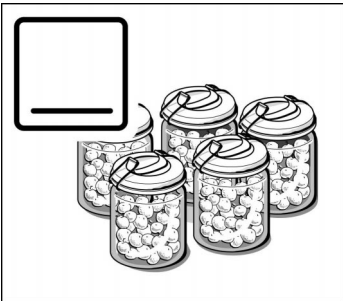

Bottom heating

You can reheat or brown meals using bottom heating. It is also the most suitable type of heating for drying food.

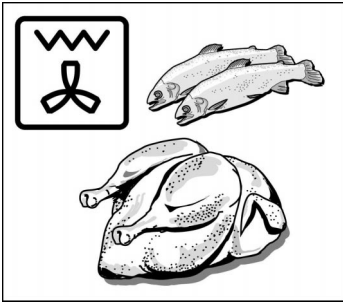

Hot air grilling

This type of heating involves the grill element and the fan switching on and off alternately. During the pause in heating, the fan circulates the heat generated by the grill around the food. This ensures that pieces of meat are crisped and brown on all sides.

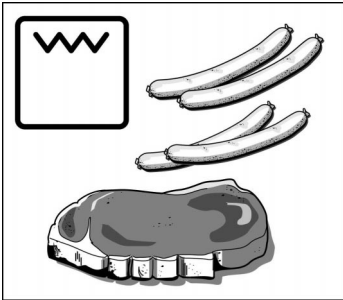

Radiant grilling

The entire area under the grill element becomes hot. This is ideal if you wish to cook several steaks, sausages, fish or slices of toast.

Oven and shelving accessories

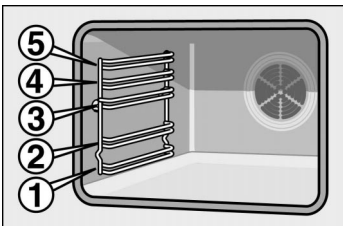

The shelf can be inserted at 5 different heights in the oven.

Maximum pull-out point

You can remove the shelf two thirds of the way without it tipping. Food can therefore easily be removed without the need to reach into a hot oven.

Accessories

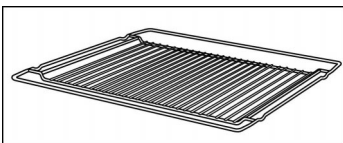

Wire racks

For ovenware, cake tins, roasts, grilling and frozen meals. Insert the wire rack curving downwards .

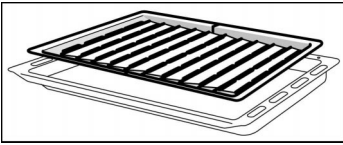

Grill pan

Can be used for grilling instead of the wire grill or as a spray guard to protect the oven against dirt. Only use the grill pan in the universal pan.

To grill using the grill pan: use the same shelf height as for the wire grill.

Using the grill pan as a spray guard: insert the universal pan with the grill pan under the wire grill.

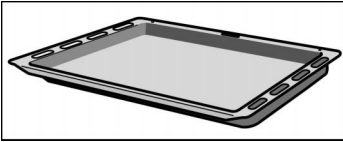

Universal pan

for moist cakes, pastries, frozen food and large roasts. It can also be used to catch dripping fat when you are grilling directly on the wire grill.

Push the universal pan as far as possible into the oven, with the sloping edge facing towards the oven door.

Optional accessory

Optional accessories may be purchased from the after-sales service or from specialist shops. Please specify the HEZ number.

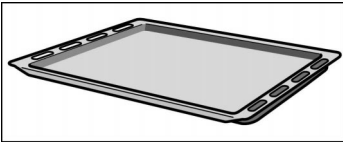

Enamel baking tray HEZ 331010 with non-stick coating

Cakes and biscuits can be removed from the baking tray more easily.

Push the baking tray as far as possible into the oven, with the sloping edge facing towards the oven door.

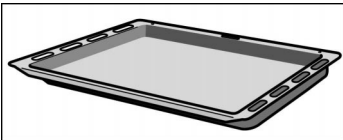

Universal pan HEZ 332010 with non-stick coating

Moist cakes, biscuits, frozen meals and large roast joints come away from the universal pan more easily.

Push the universal pan as far as possible into the oven, with the sloping edge facing towards the oven door.

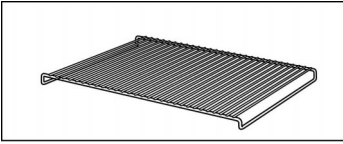

HEZ 324000 wire rack

for grilling. Always place the wire rack in the universal pan. Fat and meat juices are collected.

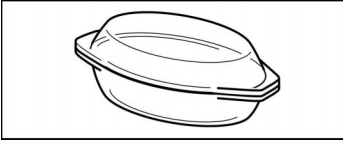

Glass roasting dish HMZ21 GB

for braised dishes and bakes that are cooked in the oven. It is especially suitable for the automatic roasting function.

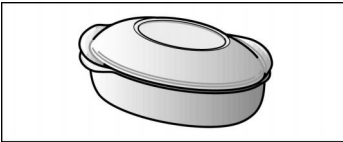

Metal roasting dish HEZ 6000

It is intended for use in the extended cooking zone of the glass ceramic hob. The dish is suitable for the sensor cooking system as well as for the automatic roasting function.

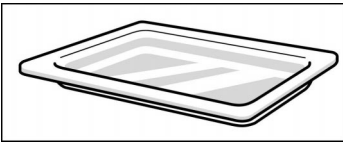

Glass pan HEZ 336000

A deep baking tray made from glass. Can also be used as a serving dish.

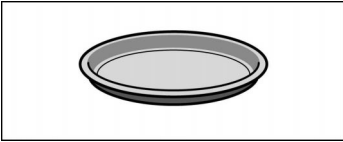

Pizza tray HEZ 317000

Ideal for pizza, frozen foods and large round cakes, for example. You can use the pizza tray instead of the universal pan. Place the tray on the wire grill. Observe the information provided in the tables.

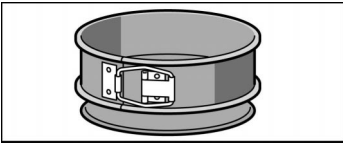

Baking tin HEZ 6001

You can bake especially moist cakes using the leak-proof baking tin. The extra wide rim prevents leakage and your cooker stays clean.

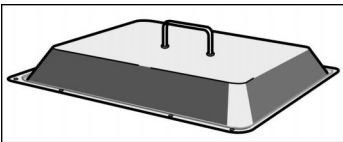

Lid for the Profi extra-deep pan HEZ 333001

Converts the Profi extra-deep pan into the Profi roasting dish.

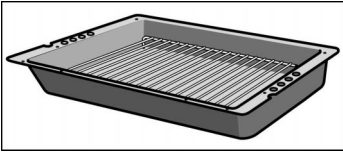

Profi extra-deep pan HEZ 333000

for cooking large quantities of food.

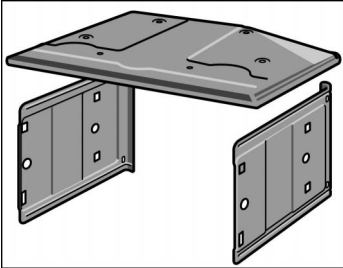

Self cleaning oven roof and side walls (EcoClean) HEZ 329020

You can retrofit your cooker with these. The oven cleans itself while it is in operation.

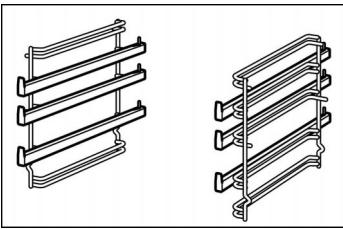

3 tier telescopic shelf HEZ 338301

The ledges at heights 2, 3 and 4 allow you to pull the shelf out further without it tipping.

Cooling fan

The oven is fitted with a cooling fan. It switches itself on and off as necessary. The warm air escapes above the door.

Before using for the first time



This section will tell you everything you need to do before using the cooker for the first time.

Heat the oven and clean the accessories. Read the safety instructions in the “Important information” section.

Firstly, check to see if the  symbol and three zeros are flashing in the display.

If the  symbol and three zeros are flashing in the display

Set the time.

1. Press the  clock button.
12:00 appears and the  clock symbol flashes.
2. Set the time using the + or – button.

The time selected is adopted after a few seconds. The cooker is now ready for use.

Heating up the oven

Method

Heat the empty oven with the door closed to remove the new oven smell.

1. Set the function selector to .
2. Use the temperature selector to set the temperature to 240 °C.

Switch off the function selector after 60 minutes.

Pre-cleaning the accessories

Please wash the accessories thoroughly with soapy water and a cleaning cloth before using them.

Setting the oven

Switching off the oven manually

You have various options for setting the oven.

When your meal is ready, switch off the oven yourself.

The oven switches off automatically

You can leave the kitchen for a long period.

The oven switches on and off automatically

You can put your meal in the oven in the morning, for example, and set the oven so that your meal is ready at midday.

Tables and tips

The correct settings for many dishes can be found in the Tables and tips section.

Switching off the oven manually

Example: Top/bottom heating, 190 °C

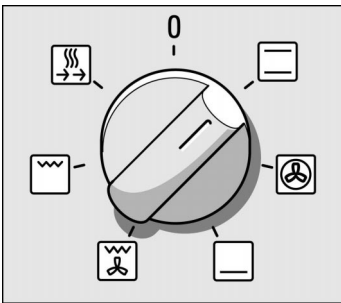

1. Select the desired type of heating using the function selector.

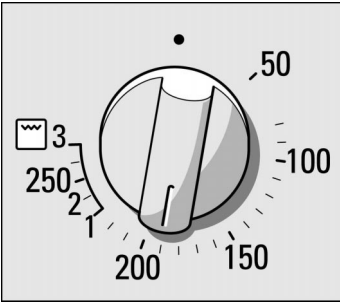

- Use the temperature selector to set the temperature or grill setting.

When the meal is ready

Switch off the function selector.

Changing the setting



You may change the temperature or grill setting at any time.

If the oven is to switch off automatically

Perform the settings as described in items 1 and 2. Set the cooking time (duration) for your meal.

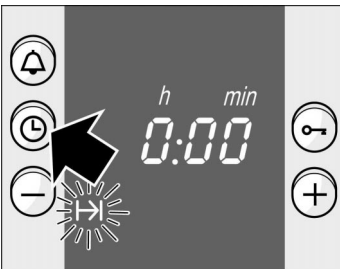
Example: Cooking time of 45 minutes



- Press the  clock button.
The cooking time symbol  will flash.



- Set the cooking time using the + or – button.
+ button default value = 30 minutes.
– button default value = 10 minutes.

The oven switches on after a few seconds. The  symbol lights up in the display.

The cooking time has elapsed

Changing the setting

Cancelling the setting

Setting the cooking time when the clock time is hidden

If the oven is to switch on and off automatically

Example: Imagine – it's 10:45 a.m. The meal will take 45 minutes to cook and must be ready at 12:45 pm.

A signal sounds. The oven switches off. Press the  button twice and switch off the function selector.

Press the  clock button. Change the cooking time using the + or – button.



Press the  clock button. Press the – button until the display is at zero. Switch off the function selector.

Press the  clock button twice and perform the setting as described in item 4.

Please remember that easily spoiled foods must not be allowed to remain in the oven for too long.

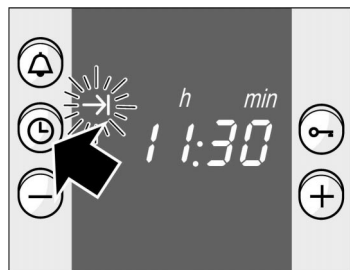
Perform the settings as described in items 1 to 4. The oven starts.



5. Press the  clock button until the  symbol flashes. In the display you will see the time when the meal will be ready.



6. Use the + button to set a later end time.

The setting is adopted after a few seconds. The display will show the end time until the oven switches on.

The cooking time has elapsed

A signal sounds. The oven switches off. Press the  button twice and switch off the function selector.

Note

You can change the setting while the symbol is flashing. The setting has been adopted if the symbol lights up permanently. You may change the waiting time that elapses before the setting is adopted. See the Basic settings section for more details.

Rapid heating

This allows you to heat up the oven particularly quickly.

Setting procedure

1. Switch the function selector to rapid heating .
2. Use the temperature selector to set the required temperature.

The oven switches on after a few seconds. The symbol  lights up in the display.

The symbol  disappears.

Put your meal in the oven and set the oven.

The rapid heating process is complete

Time

When the oven is first connected, or following a power cut, the ⌚ symbol and three zeros flash in the display. Set the time.

The function selector must be switched off.

Setting procedure

Example: 13:00

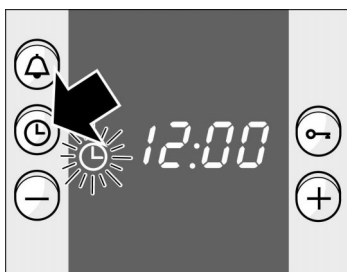

1. Press the ⌚ clock button.
12.00 appears in the display and the ⌚ symbol flashes.

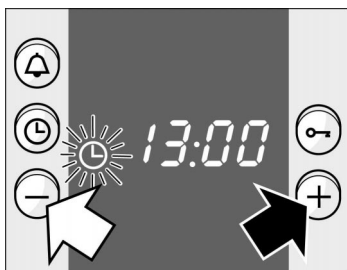

2. Set the time using the + or – button.

The time selected is adopted after a few seconds.

Changing the time e.g. from summer to winter time

Press the ⌚ clock button twice and change the time with the + or – button.

Hiding the time

You can hide the time. It will then only be visible when you are performing settings. To do this, you must change the basic setting. See the Basic settings section.

Timer

You can use the timer as a kitchen timer. It operates independently of the oven.

The timer has a special signal. This means that you can tell whether the set timer period has elapsed or the cooking time is complete.

You can also set the timer if the childproof lock is active.

Setting procedure

Example: 20 minutes

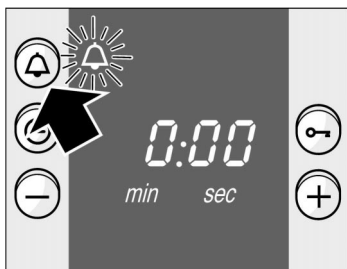

1. Press the  timer button.
The  symbol will flash.



2. Set the timer period using the + or – button.
+ button default value = 10 minutes.
– button default value = 5 minutes.

The timer starts after a few seconds. The  symbol lights up in the display. The time counts down visibly.

The time has elapsed

A signal sounds. Press the  timer button. The timer display will go out.

Changing the timer period

Press the  timer button. Change the time using the + or – button.

Cancelling the setting

Press the  timer button. Press the – button until the display is at zero.

The timer and cooking time count down simultaneously

The symbols light up. The timer period counts down visibly in the display.

To call up the remaining cooking time **I→I**, end time **→I** or time **⌚**: Press the **⌚** clock button until the symbol in question flashes.

The value called up will then appear in the display for a few seconds.

Basic settings

Your oven has several basic settings. You may change the basic settings for time, the signal duration and the reset time for a setting.

Basic setting	Function	Change to
Time ⌚ I = Time in the foreground	Time display	Time ⌚ = Time hidden
Signal duration ⚡ 2 = approx. 2 mins.	Signal after cooking time or timer period has elapsed.	Signal duration I = approx. 10 seconds 3 = approx. 5 mins.
Reset time I→I 2 = medium	Waiting time between the adjustment increments before the setting is adopted.	Reset time I = short 3 = long

Changing the basic settings

Example: Hiding the time

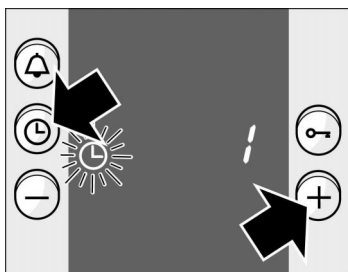

There must be no program set.

1. Press the ⌚ clock button and the + button at the same time until a *t* appears in the display. This is the basic setting for the time in the foreground.

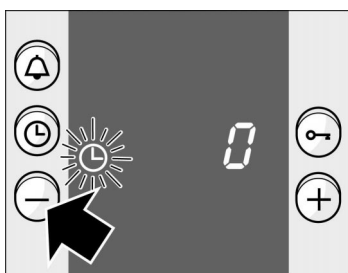

2. Change the basic setting using the + or – button.

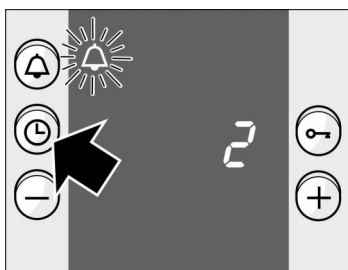

3. Confirm with the ⌚ clock button.

A *2* will appear in the display for the basic setting for the signal duration.

You do not wish to change all the basic settings

Correcting settings

Change the basic setting as described in step 2 and confirm with the ⌚ clock button. You can now change the reset time. To finish press the ⌚ clock button.



If you do not wish to change a basic setting, press the ⌚ clock button. The next basic setting will appear.

You may change your settings again at any time.

Childproof lock

The oven has a childproof lock to prevent children from switching it on accidentally.

Locking the oven

Press the  key button until the  symbol appears in the display. This will take approximately 4 seconds.

Unlocking

Press the  key button until the  goes out.

Notes

You can set the timer and the clock even when the oven is locked.

The childproof lock setting will be lost if there is a power cut.

Care and cleaning

Do not use high-pressure cleaners or steam jets.

Oven exterior

Wipe the oven with water and a little washing-up liquid. Dry it with a soft cloth.

Caustic or abrasive substances are not suitable. If any such substances come into contact with the frontage, wipe it off immediately with water.

Slight differences in the colours on the appliance front are caused by the use of different materials, such as glass, plastic and metal.

Appliances with stainless steel fronts

Always remove any flecks of limescale, grease, cornflour and egg white immediately. Corrosion can form under such flecks.

Use stainless steel care products. Follow the manufacturer's instructions. Try out the product on a small area first, before using on the whole surface.

Appliances with aluminium fronts

Use a mild window-cleaning detergent. Wipe the area with a soft window cloth or a fluff-free micro-fibre cloth, using a horizontal action without applying pressure.

Aggressive cleaning products, scratchy sponges and rough cleaning cloths are not suitable.

Oven

Never use coarse scouring pads or cleaning sponges. Oven cleaner may only be used on enamelled oven surfaces.

For ease of cleaning

you can switch on the oven light and detach the oven door.

Switching on the oven light

Set the function selector to .

Detaching the oven door

The oven door can be easily detached.

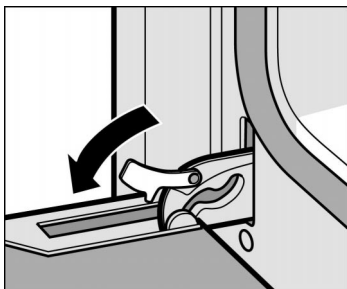

1. Open the oven door fully.
2. Move the two locking levers on the left and right-hand sides.

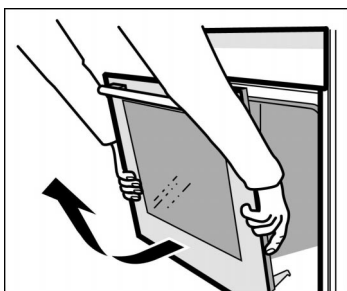

3. Half-close the oven door.
With both hands, grip the bottom of the door on the left and right-hand sides.
Close the door a little more and pull it out.

After cleaning, re-install the oven door, following the instructions in reverse order.

Cleaning the catalytic surfaces of the oven

The rear wall of the oven is coated with self-cleaning enamel. The surface cleans itself while the oven is in operation. Large splashes sometimes only disappear after the oven has been used several times.

Never use oven cleaner on the back wall of the oven.

Should the enamel become slightly stained, this will not affect its self-cleaning properties.

Cleaning the oven floor, the oven ceiling and the side walls

Use hot soapy water or a vinegar solution.

It is best to use oven cleaner if the oven is very dirty.

Only use oven cleaner in a cold oven.

Never use oven cleaner on the self-cleaning rear wall of the oven.

Note:

Enamel is baked on at very high temperatures. This can cause some slight colour variation. This is normal and does not affect the function. Do not use coarse scouring pads or strong cleaning agents to remove such discolorations.

The edges of thin trays cannot be completely enamelled. As a result, these edges can be rough. Anti-corrosion protection is guaranteed.

Cleaning the glass cover for the oven light

It is best to clean the glass cover with washing-up liquid.

Cleaning the glass panels

The glass panel on the oven door can be removed to assist in cleaning.

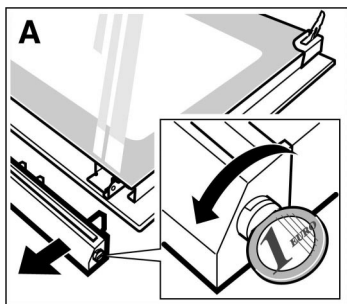

1. Remove the oven door and lay it on a cloth with the handle underneath.
2. Unscrew the cover on top of the oven door. Turn the screws clockwise or anti-clockwise with a coin to do this. (Fig. A)

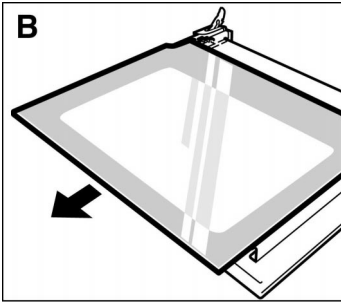

3. Slide out the panel. (Fig. B)

Clean the glass panel with glass cleaner and a soft cloth.

4. Push the panel back in. Make sure that the smooth surface is facing outwards.

5. Replace the cover and screw it back on.

6. Refit the oven door.

The oven must not be used again until the panel has been correctly installed.

Cleaning the rails

The rails can be removed for cleaning.

To unhook the rails:

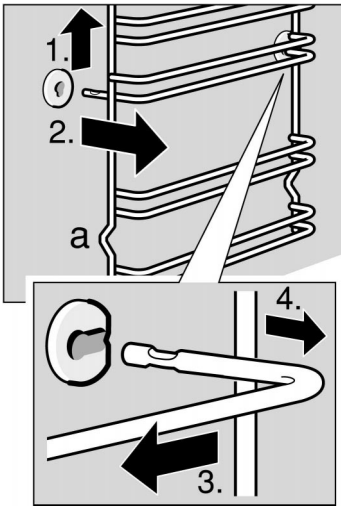

1. Lift the rails at the front in an upwards direction

2. and unhook them,

3. then pull the rails forward

4. and remove

Clean the rails using either washing-up liquid and a sponge or a brush.

To hook rails back into position:

Insert the rails at the rear, push them backwards slightly and hook them in at the front.

The rails fit both the left and right sides. Recess (a) must always be at the bottom.

Seal

Clean the seal on the oven with washing-up liquid. Never use caustic or abrasive detergents.

Accessories

Immediately after use, soak the accessories in washing-up liquid. Food residues can then be easily removed with a brush or sponge.

The grill pan parts can be soaked in the universal pan or cleaned in a dishwasher.

Troubleshooting

Should a malfunction occur, it is often only due to a minor fault. Please read the following instructions before calling the after-sales service:

Problem	Possible cause	Comments/remedy
The oven does not work.	Blown fuse.	Look in the fuse box and check that the fuse is in working order.
The clock display flashes.	Power cut	Reset the time.

Repairs may only be carried out by fully trained after-sales service technicians.

Improper repairs may constitute serious hazards to the user.

Replacing the oven light

If the oven light fails, it must be replaced. 40 watt heat-resistant spare bulbs can be obtained from the after-sales service or specialist shops. Only use these bulbs.

Method



1. Switch off the oven fuse in the fuse box.
2. Place a tea towel in the cold oven to prevent damage.
3. Unscrew the glass cover by turning it anti-clockwise.
4. Replace the oven light with one of the same type.
5. Screw the glass cover back on.
6. Remove the tea towel and switch the fuse back on.

Replacing the glass cover

The glass cover on the oven light must be replaced if it is damaged. Replacement glass covers may be obtained from the after-sales service. To this end, please specify the E number and FD number of your appliance.

After-sales service

Our after-sales service is there for you if your oven needs repairing. You will find the address and telephone number of your nearest after-sales service centre in the phone book. The after-sales service centres listed will also be happy to advise you of a service point in your local area.

E number and FD number

Please quote the E number (product number) and the FD number (production number) of your appliance when contacting the after-sales service. The rating plate containing these numbers is found on the right, on the side of the oven door. You can make a note of these numbers in the space below to save time in the event of your appliance malfunctioning.

E no.	FD no.
-------	--------

After-sales service 

Packaging and old appliances

Your new appliance was protected by suitable packaging while it was on its way to you. All materials used for this purpose are environmentally friendly and can be recycled. Please make a contribution to protecting the environment by disposing of the packaging appropriately.

Old appliances are not worthless rubbish. Environmentally-conscious recycling can reclaim valuable raw materials. Before disposing of your old appliance, please make sure that it is unusable, or label it with a sticker stating “Caution, scrap”.

Up-to-date information on how to dispose of your old appliance and the packaging from the new one can be obtained from your retailer or local authority.

Tables and tips

This table contains a selection of dishes and the optimum settings at which to cook them. You can find out which type of heating and temperature is best for your dish, which accessories to use, and at which oven level the dish should be inserted. You will find a variety of tips about ovenware and preparation, and a small troubleshooting section in case anything should go wrong.

Cakes and pastries

Baking tins

It is best to use dark baking tins. You should use 3D hot air when using thin baking tins, or glass containers. This means, however, that the baking time is increased and the cake does not brown so evenly.

Always place the cake tin on the wire grill.

If you are cooking using three tins at the same time, position these as illustrated.

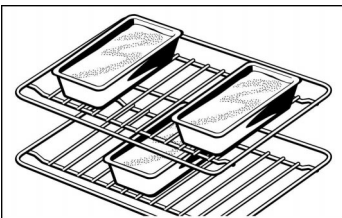

Tables

The values in the table apply to dishes placed in a cold oven. This saves energy. Shorten the baking times indicated by 5 to 10 minutes if you have preheated the oven.

The tables show which type of heating is best for different cakes and bakes.











The temperature and cooking time you select depends on the quantity and type of pastry. This is why “ranges” are given in the tables. You should try to use a lower temperature setting to start with, since this allows more even browning. If necessary, use a higher temperature setting the next time.

More information can be found in the “Baking tips” section which follows the tables.

Cakes in tins	Tin on the wire grill	Level	Type of heating	Temperature in °C	Baking time in minutes
Sponge cake, simple	Round/Vienna ring/ rectangular tin	2	☐	170-190	50-60
	3 cake tins*	1+3	☉	150-170	75-105
Sponge cake, delicate (e.g. pound cake)	Round/Vienna ring/ rectangular tin	2	☐	150-170	60-70
	3 cake tins*	1+3	☉	140-160	75-105
Short pastry base with edge	Springform cake tin	1	☐	170-190	25-35
Cake base made from sponge mixture	Fruit cake base	2	☐	150-170	20-30
Sponge cake	Springform cake tin	2	☐	160-180	30-40
Fruit cake or cheesecake, short crust pastry**	Non-stick springform cake tin	1	☐	170-190	70-90
Fruit cake, fine sponge mixture	Springform cake tin/ bowl mould	2	☐	160-180	50-60
Savoury bakes** (e.g. quiche/onion tart)	Springform cake tin	1	☐	180-200	50-60



* Please position the tins correctly. Additional wire grills may be obtained as optional accessories from specialist shops.

** Allow cakes to cool in the oven for approximately 20 minutes.











Cakes on the tray		Level	Type of heating	Temperature in °C	Baking time in minutes
Sponge or yeast pastry with dry topping	Universal pan	2		160-180	20-30
	Baking tray* + universal pan**	2+4		160-180	40-50
Sponge or yeast pastry with fruit topping	Universal pan	3		170-190	40-50
	Baking tray* + universal pan**	2+4		160-180	55-65
Swiss roll (preheat)	Universal pan	2		170-190	15-20
Plaited loaf made with 500 g flour	Universal pan	2		170-190	30-40
Stollen made with 500 g flour	Universal pan	3		160-180	60-70
Stollen made with 1 kg flour	Universal pan	3		150-170	90-100
Strudel, sweet	Universal pan	2		180-200	55-65
Pizza	Universal pan	2		220-240	25-35
	Baking tray* + universal pan**	2+4		180-200	45-55

* You can obtain an additional baking tray from a specialist shop or from the after-sales service.

** Always place the universal pan above the tray when you are cooking on two levels at once.

Bread and rolls		Level	Type of heating	Temperature in °C	Cooking time in minutes
Bread made from 1.2 kg flour* (preheat)	Universal pan	2		270	8
				200	35-45
Sour dough bread made from 1.2 kg flour* (preheat)	Universal pan	2		270	8
				200	40-50
Bread rolls (e.g. rye rolls)	Universal pan	3		200-220	20-30

* Never pour water directly into a hot oven.

Small baked products		Level	Type of heating	Temperature in °C	Baking time in minutes
Biscuits	Universal pan	3		150-170	10-20
	Baking tray* + universal pan**	2+4		130-150	30-40
	2 baking trays* + universal pan***	2+3+5		130-150	35-45
Meringue	Universal pan	3		80-100	105-155
Cream puffs	Universal pan	2		200-220	30-40
Macaroons	Universal pan	3		100-120	30-40
	Baking tray* + universal pan**	2+4		100-120	40-50
	2 baking trays* + universal pan***	2+3+5		100-120	45-55
Puff pastry	Universal pan	3		190-210	25-35
	Baking tray* + universal pan**	2+4		180-200	30-40
	2 baking trays* + universal pan***	2+3+5		180-200	40-50

* Additional baking trays may be obtained as optional accessories from specialist shops.

** Always place the universal pan above the tray when you are cooking on two levels at once.

*** Insert the universal pan at the bottom of the oven. This can be removed before cooking.

Baking tips

You wish to cook to your own recipe.

Refer to the instructions in the tables for similar types of food.

How to check that a sponge cake is cooked properly.

Approximately 10 minutes before the end of the baking time given in the recipe, pierce the tallest point of the cake with a cocktail stick. The cake is done if the cocktail stick comes out clean.

The cake collapses.

Next time, use less liquid or decrease the oven temperature by 10 degrees. Observe the cooking times in the recipe.

The cake has risen in the centre but is lower at the edges.

Do not grease the sides of the springform cake tin. As soon as the cake is done, carefully loosen the cake around the edges using a knife.

The cake is too dark at the top.

Insert it at a lower level in the oven, select a lower temperature and cook the cake a little while longer.

The cake is too dry.

Use a toothpick to make small holes in the finished cake. Then drizzle fruit juice or alcohol over the top. Next time you should decrease the temperature by around 10 degrees and reduce the baking times.

The bread or cake (e.g. cheesecake) looks fine, but is soggy on the inside (soft, with watery areas).

Next time you should add a little less liquid and cook for a little longer at a lower temperature. Cakes with fruit topping: Precook the base first of all. Sprinkle with almonds or breadcrumbs and then place the topping over this. Please observe the recipe and the baking times.

The pastry is unevenly browned.

Select a slightly lower temperature to ensure that the pastry is baked more evenly. Delicate pastry should be baked on one level using top/bottom heating . Baking paper that protrudes over the food can affect the air circulation. For this reason, always cut the baking paper to fit the baking tray.

The fruit cake is too light at the bottom. The fruit juice flows over.

Use the deeper universal pan next time.

You were baking on several levels. The food on the top baking tray is darker than that on the bottom baking tray.

Always use 3D hot air  when baking on several levels. Baking trays that are placed in the oven at the same time will not necessarily be ready at the same time.

Condensation is formed when baking cakes containing fresh fruit.

Baking may result in the formation of water vapour. It escapes above the door handle. The steam may settle and form water droplets on the control panel or on the fronts of adjacent units. This is a normal physical process.

Meat, poultry, fish

Ovenware

You may use any heat-resistant dishes. The universal pan is also suitable for larger roasts.

Always place the dishes in the centre of the wire grill.

Hot glass dishes should be placed on a dry kitchen towel after being removed from the oven. The glass could crack if placed on a cold or wet surface.

Advice on roasting

The roasting result depends on the type and quality of meat.

Add 2 to 3 soup spoons of liquid to lean meat, and 8 to 10 soup spoons of liquid to pot roasts, depending on the size.

Meat should be turned half way through the cooking time.

When the roast is ready, switch off the oven and leave the roast to stand for 10 minutes with the oven door closed. This allows the meat juices to distribute more favourably.

Advice on grilling

Always close the oven door when grilling.

If possible, use pieces of meat which are of the same thickness. They should be at least 2 to 3 cm thick. Such pieces will be browned evenly and stay juicy and soft in the middle. Only salt the steaks after they have been grilled.





















Place the pieces of meat directly onto the wire grill. If you are grilling just one piece of meat, it will turn out best if you place it in the centre of the wire grill. You should also insert the universal pan with the grill pan at level 1. The meat juices are collected here and the oven is kept clean.

Turn the pieces of meat after two thirds of the cooking time indicated.

The grill element automatically switches itself off and back on again. This is normal. The number of times this happens depends on the grill setting you have selected.

Meat

The table applies to insertion into a cold oven. The time specifications are provided as guidelines only and depend on the type and quality of the meat.

Meat	Weight	Ovenware	Level	Type of heating	Temperature in °C, grill	Cooking time in minutes
Beef pot roast (e.g. ribs)	1 kg		2		200-220	80
	1.5 kg	Covered	2		190-210	100
	2 kg		2		180-200	120
Sirloin of beef	1 kg		2		210-230	70
	1.5 kg	Uncovered	2		200-220	80
	2 kg		2		190-210	90
Sirloin, medium-rare*	1 kg	Uncovered	1		210-230	40
Steaks, well done		Wire rack***	5		3	20
Steaks, medium rare		Wire rack***	5		3	15
Pork without rind (e.g. neck)	1 kg		1		190-210	100
	1.5 kg	Uncovered	1		180-200	140
	2 kg		1		170-190	160
Pork with rind** (e. g. shoulder, leg)	1 kg		1		180-200	120
	1.5 kg	Uncovered	1		170-190	150
	2 kg		1		160-180	180
Smoked pork on the bone	1 kg	Covered	2		210-230	70
Meat loaf	750 g	Uncovered	1		170-190	70
Sausage	approx. 750 g	Wire rack***	4		3	15
Roast veal	1 kg	Uncovered	2		190-210	100
	2 kg		2		170-190	120
Leg of lamb without bone	1.5 kg	Uncovered	1		150-170	120

* Turn roast beef after half the cooking time. After cooking, wrap the sirloin in aluminium foil and leave in the oven to stand for 10 minutes.

** Make cuts in the pork rind and place the pork in the dish if the pork is to be turned, first place the pork with the rind side down.

*** Insert the universal pan at level 1.

Poultry

The table applies to dishes placed in a cold oven.







The weights indicated in the table refer to oven-ready poultry (without stuffing).

If you are grilling directly on the wire rack, you should also insert the universal pan at level 1.

Pierce the skin of duck or goose under the wings to enable the fat to run off.





Turn whole poultry after two thirds of the grilling time.

Poultry will turn out particularly crispy and brown if you baste it towards the end of the roasting time with butter, salted water or orange juice.

Poultry	Weight	Ovenware	Level	Type of heating	Temperature in °C	Cooking time in minutes
Chicken halves, 1 to 4	400 g each	Wire rack*	2		200-220	40-50
Chicken pieces	250 g each	Wire rack*	2		200-220	30-40
Whole chickens, 1 to 4	1 kg each	Wire rack*	2		190-210	50-80
Duck	1.7 kg	Wire rack*	2		170-190	90-100
Goose	3 kg	Wire rack*	2		150-170	110-130
Young turkey	3 kg	Wire rack*	2		170-190	80-100
2 turkey drumsticks	800 g each	Wire rack*	2		180-200	90-110

Fish

The table applies to dishes placed in a cold oven.

Fish	Weight	Ovenware	Level	Type of heating	Temperature in °C, grill	Cooking time in minutes
Grilled fish	300 g each	Wire rack*	3		Setting 2	20-25
	1 kg		2		180-200	45-50
	1.5 kg		2		170-190	50-60
Sliced fish (e.g. steaks)	300 g each	Wire rack*	4		Setting 2	20-25

* Insert the universal pan at level 1.

Tips for roasting and grilling

The table does not contain specifications for the weight of the roast.

Select the next lowest weight from the instructions and extend the time.

How can you tell when the roast is ready.

Use a meat thermometer (available from specialist stores) or implement a “spoon test”. Press a spoon onto the roast. If it feels firm, it is ready. If it can be pressed in, it needs to be cooked for a little longer.

The roast is too dark and the crackling is partly burnt.

Check the insertion level and temperature.

The roast looks good, but the sauce is burnt.

Next time, use a smaller roasting dish and add more liquid.

The roast looks good, but the sauce is too light and watery.





Next time, use a larger roasting dish and add less liquid.



Steam rises from the roast when the stock is added.

Most escapes through the steam outlet, some may condense on the cool control panel front or the surrounding cabinets where it will drip off. This will be dependent on the physical conditions.

Bakes, gratins, toast

The table applies to dishes placed in a cold oven.

Meal	Ovenware	Level	Type of heating	Temperature in °C, grill	Cooking time in minutes
Sweet bakes (e.g. quark and fruit bake)	Casserole dish	2		180-200	40-50
Savoury bakes made from cooked ingredients (e.g. pasta bake)	Casserole dish or universal pan	2		210-230	30-40
		2		210-230	20-30
Savoury bakes made from raw ingredients* (e.g. potato gratin)	Casserole dish or universal pan	2		150-170	50-60
		2		150-170	50-60

Meal	Ovenware	Level	Type of heating	Temperature in °C, grill	Cooking time in minutes
Toast	Wire rack	4		3	4-5
Toast with topping	Wire rack**	4		3	5-8





* The bake must be no higher than 2 cm.

** Always insert the universal pan at level 1.

Frozen foods

Please observe the instructions on the packaging.

The values in the table apply to dishes placed in a cold oven.

Meal		Level	Type of heating	Temperature in °C	Cooking time in minutes
Fruit strudel*	Universal pan	3		190-210	45-55
French fries*	Universal pan	3		210-230	25-30
Pizza*	Wire grill	2		200-220	15-20
Pizza baguette*	Wire grill	2		190-210	15-20

* Line the accessories with greaseproof paper. Please ensure that the greaseproof paper is suitable for use at these temperatures.

Note

The universal pan may become warped when baking frozen foods. This is caused by the considerable temperature fluctuations which affect the accessories. This warping is eliminated during the baking process.

Defrosting

Remove the food from its packaging and place it in a suitable dish on the wire grill.

Please observe the instructions on the packaging.

The defrosting times depend on the type and amount of food.





Meal	Accessories	Level	Type of heating	Temperature in °C
Frozen foods* e.g. cream gateaux, cream cakes, cakes with chocolate or icing, fruit, chicken, sausages and meat, bread, rolls, pastries and other baked goods	Wire rack	2		The temperature selector remains switched off
* Cover frozen food with microwave foil. Place poultry onto the plate with the breast side down.				

Drying

Only use perfectly fresh fruit and vegetables, and wash them thoroughly.

Allow the food to drain well and dry it yourself.

Line the universal pan and wire rack with baking paper or greaseproof paper.

Meal	Level	Type of heating	Temperature in °C	Cooking time in hours
600 g apple rings	2 + 4		80	Approx. 5
800 g sliced pears	2 + 4		80	Approx. 8
1.5 kg prunes or plums	2 + 4		80	Approx. 8 - 10
200 g fresh herbs, washed	2 + 4		80	Approx. 1½

Note

Very moist fruit or vegetables should be turned several times. Once dried, remove the food from the paper immediately.

Preserving

Preparation

The jars and rubber sealing rings must be clean and intact. Use jars of the same size if possible. The instructions in the table refer to round 1-litre jars. Caution Do not use larger or taller jars. The lid could crack.

Only use perfectly fresh fruit and vegetables. Wash them thoroughly.

Pour the fruit or vegetables into the jars. Wipe clean the tops of the jars again if necessary. They must be clean. Place a wet rubber sealing ring and lid on each jar and lock the jars using clamps.

Do not place more than six jars in the oven.

The times specified in the tables are guidelines only. They can be influenced by the room temperature, the number of jars and the amount and temperature of the jar contents. Before you change settings or switch off the appliance, make sure that the contents of the jars are actually bubbling.

Setting procedure

1. Place the universal pan on level 2. Place the jars inside the pan so that they do not come into contact with each other.
2. Pour ½ litre of hot water (approx. 80 °C) into the universal pan.
3. Close the oven door.
4. Switch the function selector to .
5. Set the temperature selector to 170 to 180 °C.

Preserving fruit

As soon as the contents of the jars begins to simmer, that is when small bubbles appear at short intervals - after about 40 to 50 minutes - turn off the temperature selector. The function selector remains switched on.

The jars should be removed from the oven after being reheated for 25 to 35 minutes. If the food is left to cool in the oven for longer, bacteria might form, causing the preserved fruit to spoil prematurely. Switch off the function selector.

Fruit in 1-litre jars	After bubbling	Reheating
Apples, red/blackcurrants, strawberries	turn off	approx. 25 minutes
Cherries, apricots, peaches, gooseberries	turn off	approx. 30 minutes
Apple purée, pears, plums	turn off	approx. 35 minutes

Preserving vegetables

As soon as the contents of the jars begins to simmer, set the temperature selector back to approximately 120 to 140 °C. The table shows when you can switch off the temperature selector. Allow the vegetables to stand in the oven for a further 30 to 35 minutes. The function selector remains switched on during this time.

Vegetables with cold stock in 1-litre jars	After bubbling 120 - 140 °C	Reheating
Cucumbers	–	approx. 35 minutes
Beetroot	approx. 35 minutes	approx. 30 minutes
Brussel sprouts	approx. 45 minutes	approx. 30 minutes
Beans, kohlrabi, red cabbage	approx. 60 minutes	approx. 30 minutes
Peas	approx. 70 minutes	approx. 30 minutes

Remove the jars

Never place the hot jars on a cold or wet surface as this could cause the glass to crack.

Energy saving tips

Only preheat the oven if it specifies in the recipe or in the table in the instruction manual that you should do so.

Use non-stick, black painted or enamelled tins. They absorb the heat especially well.

If you have several cakes to bake it is best to bake them one after the other. The oven is still warm. This shortens the baking time for the second cake. You can also put two baking tins in one after the other.

For long cooking times, the oven can be switched off 10 minutes before the end of the cooking time and the remaining heat can be used to finish the cooking.

Acrylamide in food

Experts are currently discussing how dangerous acrylamide in food can be. We have compiled this information sheet for you on the basis of current research.

Where does acrylamide come from?

Acrylamide in food does not come from external contamination. It is formed in the food itself during preparation - provided that the food contains carbohydrate and protein. Exactly how this happens has not yet been completely explained. However, it appears that the acrylamide content is strongly influenced by:

- high temperatures
- a low water content in food
- intensive browning of the food.

What sort of foods are affected?

Acrylamide forms mostly in grain and potato products that are prepared at high temperatures, e.g.:

crisps, chips,
toast, rolls, bread,
baked goods made from shortcrust pastry (speciality biscuits and cakes).

What can you do?

In general

You can avoid high levels of acrylamide when baking, frying and grilling.

The following recommendations were published by AID¹ and BMVEL² to help you minimise acrylamide levels:

Keep cooking times as short as possible.

“Brown rather than burn” - cook food only until it is golden brown.

The larger and thicker the food is, the less acrylamide it contains.

Baking

Set the temperature to a maximum of 200 °C when using the top/bottom heating setting, and to a maximum of 180 °C for the 3D hot air setting.

Cookies: Set the temperature to a maximum of 190 °C when using the top/bottom heating setting, and to a maximum of 170 °C for the 3D hot air setting. The presence of egg or egg yolk in a recipe reduces the formation of acrylamide.

Spread oven chips evenly over the baking sheet in one layer where possible. To prevent the food from drying out quickly, place at least 400 g on each baking sheet.

¹ AID “Acrylamide” information leaflet, published by AID (German Evaluation and Information Service for Nutrition, Agriculture and Forestry) and BMVEL (German Federal Ministry for Consumer Protection, Food and Agriculture), as at 12/02, Internet: <http://www.aid.de>.











² BMVEL press release 365, as at 4.12.2002, Internet: <http://www.verbraucherministerium.de>

Test dishes

In accordance with DIN 44547 and EN 60350

Baking

The values in the table apply to dishes placed in a cold oven.

Meal	Accessories and notes	Level	Type of heating	Temperature in °C	Baking time in minutes
Viennese whirls	Universal pan	2		160-180	20-30
	Baking tray* + universal pan**	2+4		150-170	35-45
	2 baking trays* + universal pan***	2+3+5		150-170	45-55
Small cakes x 20	Universal pan	5		3	1-2
Small cakes, 20 per baking tray (preheat)	Baking tray* + universal pan**	2+4		150-170	30-40
	2 baking trays* + universal pan***	2+3+5		150-170	35-45
Swiss roll	Springform cake tin	2		160-180	30-40
Yeast cakes on a baking tray	Universal pan	3		170-190	40-50
	Baking tray* + universal pan**	2+4		160-180	55-65
German apple pie	2 wire racks* + 2 tinplate springform cake tins Ø 20 cm****	2+4		190-210	75-85
	Universal pan + 2 tinplate springform cake tins Ø 20 cm	1		200-220	70-80

* Baking trays may be obtained as optional accessories from specialist shops.



** Always place the universal pan above the tray when you are cooking on two levels at once.

*** Always insert the universal pan at the bottom of the oven. This can be removed before cooking.

**** Place the cakes diagonally on the accessories.

Grilling

The values in the table apply to dishes placed in a cold oven.

Meal	Accessories	Level	Type of heating	Grill setting	Cooking time in minutes
Toast (preheat for 10 mins.)	Wire rack	5		3	1-2
Beefburgers, x 12*	Wire rack	4		3	25-30

* Turn half way through the cooking time. Always insert the universal pan at level 1.

